



GAS INSERTS



regency-fire.com

WHY CHOOSE REGENCY?

At Regency, our past 40 years have been focused on providing a high-level of service while building high-quality and reliable products that our customers can enjoy for years to come.

HIGH-QUALITY

Producing a high-quality product has been at the very heart of what we do ever-since that very first stove rolled off the production line over 40 years ago. We are ever-focused on producing quality products for our customers that will last for years to come.

BEST WARRANTY

A fireplace should be reliable and should work right the first time it is used, and the 1,000th. A core part of our business is making sure that we are building long-lasting, durable, high-quality products; we back-up that commitment with the industry's best warranties on our products.

COST-EFFICIENT

Never before have home heating costs been higher. Turn your furnace way down and zone heat with our beautiful, reliable and convenient Regency products. Not only can you cut your fuel bills in half, but you'll be able to enjoy the timeless comfort of a Regency fire.

Why Regency? Because it's **more** than a fireplace!



TABLE OF CONTENTS

Regency Atmosphere Gas Inserts	
Gi25LE	06
Gi29	08
Gi33LE	10
Regency Liberty® Radiant Gas Inserts	
Regency Horizon® Radiant Gas Inserts	
LRi3E	12
HRi3E	14
LRi4E	16
HRi4E	18
LRi6E	20
HRi6E	22
Regency Energy™ Standing Pilot Gas Inserts	
Regency Liberty® Standing Pilot Gas Inserts	
E33	24
L234	26
U31	27
Specifications	35





EXPERIENCE THE
Gi29 (VIDEO):





GAS INSERTS REDEFINED

Experience The Atmosphere Collection

Re-defining what's possible with a gas insert; the Atmosphere Collection was designed from the ground up to deliver more.

Sized and designed to fit into more spaces while still maintaining an industry-leading viewing area and provide unmatched views of our new revolutionary infusion burner technology.

Pick your look with mix & match accessories totaling almost 450 different combinations of logs, faceplates, surrounds, and interior panels, so you get the look that best suits your unique style and your unique home.

Enjoy more standard features with built-in fan to help improve room heating capacity and ember-bed lighting standard on most models.

More technology, more options, more realism, and more value. With Regency's Atmosphere collection you get more!

INFUSION BURNER

Experience The Most Realistic Fire



Inspired by nature and fueled by innovation, Regency's new patent-pending infusion burner technology delivers an unparalleled realistic flame and log set.

By cleverly infusing the burner into the logs, our team of engineers have created an unmatched flame picture that wraps naturally around the logs and dances effortlessly in the firebox - giving you the appearance and beauty of a real wood fire, with all the convenience of gas.

Experience the new Infusion burner throughout our Atmosphere lineup and enjoy flames so realistic your guests will have a hard time telling whether it's wood or gas!

REGENCY ATMOSPHERE Gi25

Extra Small Gas Insert



Gi25LE shown with 3-Sided flush faceplate and driftwood log set



Gi25LE shown with 3-sided finishing trim, herringbone inner panels, and driftwood log set



Gi25LE shown with a regular faceplate, 4-sided finishing trim, painted black inner panels, and oak log set.



Gi25LE shown with a regular 3-sided faceplate, painted black inner panels, and oak log set.

NEW Gi25LE • Extra Small Gas Insert

This unit personifies the expression, "Great things come in small packages." Designed to fit into smaller spaces, the Gi25LE sports an impressive viewing area highlighting its infusion burner design, an improved high-definition artisan-crafted log set, and a modern, flush design.

SPECIFICATIONS Gi25LE

NATURAL GAS

Input (BTU)	20,500
Turn down to (BTU)	14,500
Efficiency (steady state)	68.33
EnerGuide Rating (Canada only)	63.6%

DIMENSIONS

Height	17"
Width	25"
Depth	15"
Viewing Area	212 sq. in.

Note: Fireplace opening sizes may differ depending on option chosen and type of masonry fireplace.



Gi25LE shown with 3-Sided finishing trim, brown brick panels and oak log set.



Gi25LE shown with a regular 4-sided faceplate, painted black inner panels, and oak log set.



Gi25LE shown with a regular faceplate, adjustable hearth riser, and birch log set.



Gi25LE shown with 3-sided trim, oversized backing plate, and oak log set.

STANDARD FEATURES

- NEW: innovative, patented infusion burner
- Invisimesh safety screen for a clear view of the fire
- Proflame II GTMF remote control system
- Variable speed blower for max heat distribution
- 30° angled flue for versatile installation
- Direct vent to increase efficiency & warmth retention
- Limited lifetime warranty

OPTIONS

- Multiple faceplate styles
- Multiple log set choices: oak, birch or driftwood
- Interior panels in Rustic Brown, Volcanic Black, and Herringbone
- Wifi Kit for app control
- Flush installation options
- Mantel deflector for reduced clearances
- Oversized and custom backing plates
- Hearth trim kit for raised hearth installations
- Regency flex liners

Note: Fireplace opening sizes may differ depending on option chosen and type of masonry fireplace.

REGENCY ATMOSPHERE Gi29

Medium Gas Insert



Gi29LE shown with 3-sided flush faceplate, black reflective glass inner panels, and oak log set.



Gi29LE shown with 3-sided finishing trim, black inner panels, and oak log set.



Gi29LE shown with a regular faceplate, premium brushed nickel surround, black inner panels, and oak log set.



Gi29LE shown with a regular 3-sided faceplate, painted black inner panels, and oak log set.

Gi29L | Gi29LE | Gi29LU • Medium Gas Inserts

Experience beauty in a standard sized firebox. The first of our Atmosphere Collection, the Gi29 exemplifies luxury with a dynamic flame filled firebox designed to fit into the most commonly occurring fireplace openings.

SPECIFICATIONS Gi29LE	NATURAL GAS	PROPANE
Input (BTU)	31,500	31,500
Turn down to (BTU)	17,000	17,000
Efficiency (steady state)	71.70%	70.20%
EnerGuide Rating (Canada only)	63.88%	62.33%

MINIMUM FIREPLACE OPENING	
Width (front)	29"
Width (rear)	20"
Height	20-1/4"
Depth	16-3/4"

Note: Fireplace opening sizes may differ depending on option chosen and type of masonry fireplace.



Gi29LE shown with a regular faceplate with traditional antique copper surround, volcanic black brick inner panels, and oak log set.



Gi29LE shown with a regular 4-sided faceplate, painted black inner panels, and driftwood log set.



Gi29LE shown with a regular faceplate, adjustable hearth riser, herringbone inner panels and birch log set.



Gi29LE shown with 3-sided trim, oversized backing plate, castlestone inner panels and oak log set.

STANDARD FEATURES

- NEW: innovative, patent-pending infusion burner
- Invisimesh safety screen for a clear view of the fire
- Ember bed lighting for a realistic glow (LE units only)
- Proflame II GTMF remote control system (LE units only)
- Standing pilot (Direct spark ignition - LU units only)
- Variable speed blower for max heat distribution (LE, LU units only)
- 30° angled flue for versatile installation
- Direct vent to increase efficiency & warmth retention
- Limited lifetime warranty

OPTIONS

- Oak, birch or driftwood log sets
- Faceplates in various designs
- Premium and traditional surrounds in various colors
- Interior panels in Herringbone, Castlestone, Brown, Volcanic Black or Painted Black
- Reflective black glass interior panels
- Oversized and custom backing plates
- Mantel deflector for reduced clearances
- Hearth trim kit for raised hearth installations
- Wifi Kit for app control
- Regency flex liners
- Propane conversion kit

Note: Fireplace opening sizes may differ depending on option chosen and type of masonry fireplace.

REGENCY ATMOSPHERE Gi33

Large Gas Insert



Gi33LE shown with a regular faceplate, premium sunset bronze surround, painted black inner panels, and birch log set.



Gi33LE shown with 3-sided finishing trim, black inner panels, and oak log set



Gi33LE shown with a regular faceplate, premium traditional surround in antique copper, painted black inner panels, and oak log set.



Gi33LE shown with a regular 3-sided faceplate, painted black inner panels, and oak log set.

NEW Gi33LE • Large Gas Insert

Experience beauty enlarged. The large version of our stunning Atmosphere Collection, the Gi33LE offers luxurious flame pictures and flame pictures in a big firebox. Designed to maximize heat output and flame enjoyment of the most commonly occurring large fireplace openings.

SPECIFICATIONS Gi33LE	NATURAL GAS PROPANE	
	Input (BTU)	38,500
Turn down to (BTU)	20,500	20,000
Efficiency (steady state)	68.60%	69.50%
EnerGuide Rating (Canada only)	64.30%	64.32%

MINIMUM FIREPLACE OPENING	
Width (front)	33"
Width (rear)	22-3/8"
Height	24"
Depth	18"

Note: Fireplace opening sizes may differ depending on option chosen and type of masonry fireplace.



Gi33LE shown with 4-sided finishing trim, herringbone brick inner panels, and oak log set



Gi33LE shown with a regular 4-sided faceplate, painted black inner panels, and driftwood log set.



Gi33LE shown with a regular faceplate, adjustable hearth riser, herringbone inner panels and birch log set.



Gi33LE shown with 3-sided trim, oversized backing plate, castlestone inner panels and oak log set.

STANDARD FEATURES

- NEW: innovative, patented infusion burner
- Invisimesh safety screen for a clear view of the fire
- Ember bed lighting for a realistic glow
- Proflame II GTMF remote control system
- Variable speed blower for max heat distribution
- 30° angled flue for versatile installation
- Direct vent to increase efficiency & warmth retention
- Limited lifetime warranty

OPTIONS

- Oak, birch or driftwood log sets
- Faceplates in various designs
- Premium and traditional surrounds in various colors
- Interior panels in Herringbone, Castlestone, Brown, Volcanic Black or Painted Black
- Reflective black glass interior panels
- Oversized and custom backing plates
- Mantel deflector for reduced clearances
- Hearth trim kit for raised hearth installations
- Wifi Kit for app control
- Regency flex liners
- Propane conversion kit

REGENCY LIBERTY® RADIANT LRi3E

Compact Gas Fireplace Insert



LRi3E shown with Vignette faceplate in Black and Rustic Brown interior panels.



Small backing plate and Vignette faceplate in Platinum



Regular backing plate and Vignette faceplate in Tuscan Sunset



Arched backing plate and arched Vignette faceplate in Black

COMPACT AND EFFICIENT

Regency is proud to present the newest addition to the Liberty gas insert family, now available in a smaller size to fit a larger array of spaces. Enjoy timeless, artisan-crafted logs with the combined power of radiant & convective heat. Vignette designer faceplates provide you with the choice to create a modern transitional look or a traditional look with Georgian & Tudor styles.

SPECIFICATIONS	NATURAL GAS	PROPANE
Input (BTU)	20,500	19,000
Turn down to (BTU)	14,000	15,500
Efficiency (steady state)	73.12%	74.59%
EnerGuide Rating (Canada only)	66.25%	66.70%

MINIMUM FIREPLACE OPENING (VIGNETTE FACEPLATE)	
Width (front)	28-1/2"
Width (rear)	21-5/8"
Height	19-1/2"
Depth	14-1/2"

Note: Fireplace opening sizes may differ depending on option chosen and type of masonry fireplace. See product specifications on page 36.



LRi3E shown with 4-sided regular backing plate and Vignette faceplate in Platinum.



Regular backing plate, Vignette faceplate in Black and Craftsman inlay in Black



Regular backing plate, Vignette faceplate and Door inlay in Black



Arched backing plate and arched Vignette Tudor faceplate in Black

STANDARD FEATURES

- Sleek and compact size to accommodate for a variety of spaces
- Versatile design choices to create a traditional or modern transitional look
- Log set with ceramic ember bed
- Heat radiating ceramic glass with safety screen
- Variable speed blower for max heat distribution
- Proflame II GTMF remote control system
- 30° angled flue for versatile installation
- Direct vent to increase efficiency & warmth retention
- Natural gas
- Limited lifetime warranty

OPTIONS

- Vignette faceplates in various designs and colors
- Vignette inlays in various designs and colors
- Interior panels in Old Town Red, Rustic Brown or Volcanic Black
- Reflective black enamel interior panels
- Small, regular, arched, oversized and custom backing plates
- Hearth trim kit and mantel deflector
- Regency flex liners
- Propane conversion kit

REGENCY HORIZON® RADIANT HRi3E

Compact Gas Fireplace Insert



HRi3E shown with Vignette faceplate in Black, Black Crystals with Volcanic Stones and Black Reflective Enamel panels.



Small backing plate and Vignette faceplate in Black Chrome with Starfire Crystals



Arched backing plate and arched Vignette faceplate in Black with optional volcanic stones



4-sided regular backing plate and Vignette faceplate in Platinum with Black Crystals

COMPACT AND CUSTOMIZABLE

Designed for contemporary spaces, the HRi3E is as versatile as it is beautiful. The HRi3E gas insert delivers heat efficiently and with a captivating style. Choose the look you want with a wide selection of accent options. Colored glass crystals or firebeads combine elegantly with spa stones or driftwood logs.

SPECIFICATIONS	NATURAL GAS	PROPANE
Input (BTU)	19,500	19,000
Turn down to (BTU)	14,000	15,500
Efficiency (steady state)	71.73%	72.87%
EnerGuide Rating (Canada only)	64.36%	66.24%

MINIMUM FIREPLACE OPENING (VIGNETTE FACEPLATE)	
Width (front)	28-1/2"
Width (rear)	21-5/8"
Height	19-1/2"
Depth	14-1/2"

Note: Fireplace opening sizes may differ depending on option chosen and type of masonry fireplace. See product specifications on page 36.



HRI3E shown with regular backing plate, Vignette faceplate in Platinum with Black Crystals and optional Driftwood log set.



Regular backing plate, Vignette faceplate in Black, Craftsman inlay in Black with Black Crystals and optional Driftwood log set



Regular backing plate, Vignette faceplate in Black, Door inlay in Black with Black Crystals and optional Volcanic Stones



Regular backing plate, Vignette Tudor faceplate in Black with Black Crystals and optional Volcanic Stones

STANDARD FEATURES

- Horizon contemporary linear fire bed with a generous range of media options
- Heat radiating ceramic glass with safety screen
- 6-tube heat exchanger for max efficiencies
- Variable speed blower for max heat distribution
- Electronic ignition with SureFire™ switch
- Proflame I GTMF remote control
- 30° angled flue for versatile installation
- Direct vent to increase efficiency & warmth retention
- Natural gas
- Limited lifetime warranty

OPTIONS

- Vignette faceplates in various designs and colors
- Vignette inlays in various designs and colors
- Firebeads and crystals in various colors
- Driftwood log set, Volcanic Stones, Spa Stones or River Pebbles
- Reflective black enamel interior panels
- Small, regular, arched, oversized and custom backing plates
- Hearth trim kit and mantel deflector
- Regency flex liners
- Propane conversion kit

REGENCY LIBERTY® RADIANT LRi4E

Medium Gas Fireplace Insert



LRi4E shown with regular backing plate, Vignette faceplate in Black, Door Inlay in Black and Rustic Brown Brick Panels.



Small backing plate and Vignette faceplate in Platinum



Regular backing plate and Vignette faceplate in Tuscan Sunset



4-sided regular backing plate and Vignette faceplate in Black

PERFORMANCE AND STYLE

The Liberty Radiant LRi4E gas insert exemplifies Regency's renowned commitment to quality. A source of both radiant and convective heat, the LRi4E delivers high-efficiency heat safely and reliably throughout your home. Turn on the integrated circulating fan to intensify the warming effect. This statement fireplace can be customized with Regency's selection of accent trim options.

SPECIFICATIONS	NATURAL GAS	PROPANE
Input (BTU)	31,000	31,000
Turn down to (BTU)	22,000	26,000
Efficiency (steady state)	71.45%	73.01%
EnerGuide Rating (Canada only)	70.27%	69.36%

MINIMUM FIREPLACE OPENING (VIGNETTE FACEPLATE)	
Width (front)	30"
Width (rear)	22"
Height	20"
Depth (without spacer)	18"
Depth (with spacer)	15-3/4"

Note: Fireplace opening sizes may differ depending on option chosen and type of masonry fireplace. See product specifications on page 36.



LRI4E shown with arched backing plate and decorative arched Vignette faceplate in Black.



Regular backing plate, Vignette faceplate in Black and Craftsman inlay in Black



Regular backing plate, Vignette faceplate in Black and Door inlay in Black



Regular backing plate and Vignette Georgian faceplate in Black

STANDARD FEATURES

- A variety of trims available to add a unique design touch
- Log set with ceramic ember bed
- Heat radiating ceramic glass with safety screen
- 6-tube heat exchanger for max efficiencies
- Variable speed blower for max heat distribution
- Electronic ignition with SureFire™ switch
- Proflame I GTMF remote control
- 30° angled flue for versatile installation
- Direct vent to increase efficiency & warmth retention
- Natural gas
- Limited lifetime warranty

OPTIONS

- Vignette faceplates in various designs and colors
- Vignette inlays in various designs and colors
- Faceplate spacer for shallow fireplace installations
- Interior panels in Old Town Red, Rustic Brown or Volcanic Black
- Reflective black enamel interior panels
- Small, regular, arched, oversized and custom backing plates
- Mantel deflector for reduced clearances
- Hearth trim kits for raised hearth installations
- Wall thermostat
- Regency flex liners
- Propane conversion kit

REGENCY HORIZON® RADIANT HRi4E

Medium Gas Fireplace Insert



HRi4E shown with 4-sided regular backing plate, Vignette faceplate in Platinum with Black Crystals and optional Driftwood log set.



Small backing plate and Vignette faceplate in Black with Black Crystals and optional Driftwood log set



Arched backing plate and arched Vignette faceplate in Black with optional Starfire Crystals



Regular backing plate and Vignette faceplate in Black with optional Black Crystals

MODERN AND ELEGANT

Add comfort and update the look of your home with a Regency Horizon Radiant medium-sized gas insert. Radiant inserts deliver heat efficiently and can be customized with captivating firebed options. Simply choose the style you want: combine colored glass crystals or firebeads with spa stones for natural elegance or select driftwood logs for a coastal look.

SPECIFICATIONS	NATURAL GAS	PROPANE
Input (BTU)	31,000	31,000
Turn down to (BTU)	22,000	26,000
Efficiency (steady state)	71.45%	73.01%
EnerGuide Rating (Canada only)	70.27%	69.36%

MINIMUM FIREPLACE OPENING (VIGNETTE FACEPLATE)	
Width (front)	30"
Width (rear)	22"
Height	20"
Depth (without spacer)	18"
Depth (with spacer)	15-3/4"

Note: Fireplace opening sizes may differ depending on option chosen and type of masonry fireplace. See product specifications on page 36.



HRI4E shown with regular backing plate, Vignette faceplate in Platinum and Black Crystals.



Regular backing plate, Vignette faceplate in Black, Craftsman inlay in Black with Black Crystals and optional Volcanic Stones



Regular backing plate, Vignette faceplate in Black and Door inlay in Black with Black Crystals



Regular backing plate and Vignette Tudor faceplate in Black with Black Crystals

STANDARD FEATURES

- Horizon contemporary linear fire bed with a generous range of media options
- Heat radiating ceramic glass with safety screen
- 6-tube heat exchanger for max efficiencies
- Variable speed blower for max heat distribution
- Electronic ignition with SureFire™ switch
- Proflame I GTMF remote control
- 30° angled flue for versatile installation
- Direct vent to increase efficiency & warmth retention
- Natural gas
- Limited lifetime warranty

OPTIONS

- Vignette faceplates in various designs and colors
- Vignette inlays in various designs and colors
- Faceplate spacer for shallow fireplace installations
- Driftwood log set, crystals or firebeads in various colors
- Volcanic Stones, Spa Stones, or accent River Pebbles
- Reflective black enamel interior panels
- Small, regular, arched, oversized and custom backing plates
- Mantel deflector for reduced clearances
- Hearth trim kits for raised hearth installations
- Wall thermostat
- Regency flex liners
- Propane conversion kit

REGENCY LIBERTY® RADIANT LRi6E

Large Gas Fireplace Insert



LRi6E shown with decorative arched Vignette and arched backing plate in Black.



Small backing plate and Vignette faceplate in Tuscan Sunset



Regular backing plate and Vignette faceplate in Black



4-sided regular backing plate and Vignette faceplate in Platinum

RADIANT CONVECTIVE HEAT

This large, high-efficiency heater provides intense radiant heat instantly. Enjoy strong heat in the area directly in front of your fireplace or turn on the included heat circulating blower to distribute comforting warmth into the far corners of your room. The Regency Liberty LRi6E large gas insert is a stylish, reliable source of warmth and ambiance, even during a power outage.

SPECIFICATIONS	NATURAL GAS	PROPANE
Input (BTU)	38,000	38,000
Turn down to (BTU)	25,000	30,000
Efficiency (steady state)	73.01%	73.01%
EnerGuide Rating (Canada only)	70.37%	70.37%

MINIMUM FIREPLACE OPENING (VIGNETTE FACEPLATE)	
Width (front)	34"
Width (rear)	25"
Height	24"
Depth (without spacer)	19-1/2"
Depth (with spacer)	16-3/4"

Note: Fireplace opening sizes may differ depending on option chosen and type of masonry fireplace. See product specifications on page 36.



LRi6E shown with regular backing plate, Vignette faceplate in Black, Craftsman inlay in Black.



Regular backing plate, Vignette faceplate in Black, Door inlay in Black



Regular backing plate, Vignette Tudor faceplate in Black



Arched backing plate and arched Vignette faceplate in Black

STANDARD FEATURES

- A generous range of media options, inlays, and faceplates available to customize to your liking
- Black steel interior panels
- Log set with ceramic ember bed
- Heat radiating ceramic glass with safety screen
- 6-tube heat exchanger for max efficiencies
- Variable speed blower for max heat distribution
- Electronic ignition with SureFire™ switch
- Proflame I GTMF remote control
- 6-tube heat exchanger for max efficiencies
- 30° angled flue for versatile installation
- Direct vent to increase efficiency & warmth retention
- Natural gas
- Limited lifetime warranty

OPTIONS

- Vignette faceplates in various designs and colors
- Vignette inlays in various designs and colors
- Faceplate spacer for shallow fireplace installations
- Interior panels in Old Town Red, Rustic Brown or Volcanic Black
- Reflective black enamel interior panels
- Small, regular, arched, oversized and custom backing plates
- Mantel deflector for reduced clearances
- Hearth trim kits for raised hearth installations
- Wall thermostat
- Regency flex liners
- Propane conversion kit

REGENCY HORIZON® RADIANT HRi6E

Large Gas Fireplace Insert



HRi6E shown with regular backing plate, Vignette faceplate in Black Chrome, Black Crystals with Volcanic Stones and Black Reflective Enamel panels.



Small backing plate, Vignette faceplate in Platinum with Black Crystals and optional Volcanic Stones



Arched backing plate, arched Vignette faceplate in Black with Black Crystals and optional Driftwood log set



4-sided regular backing plate, Vignette faceplate in Black with Black Crystals

SLEEK AND CONTEMPORARY

The Regency Horizon Radiant Series introduces a sleek, contemporary large gas insert designed to transform your existing fireplace. Choose from a selection of modern Vignette faceplates and firebed options to create a unique look. Backed by the industry's best warranty, the HRi6E provides reliable, high-efficiency heat with exceptional styling.

SPECIFICATIONS	NATURAL GAS	PROPANE
Input (BTU)	38,000	38,000
Turn down to (BTU)	25,000	30,000
Efficiency (steady state)	73.01%	73.01%
EnerGuide Rating (Canada only)	70.37%	70.37%

MINIMUM FIREPLACE OPENING (VIGNETTE FACEPLATE)	
Width (front)	34"
Width (rear)	25"
Height	24"
Depth (without spacer)	19-1/2"
Depth (with spacer)	16-3/4"

Note: Fireplace opening sizes may differ depending on option chosen and type of masonry fireplace. See product specifications on page 36.



HRI6E shown with regular backing plate, Vignette faceplate in Black with Black Crystals and optional Driftwood log set.



Regular backing plate, Vignette faceplate in Black and Door inlay in Black with Black Crystals



Regular backing plate, Vignette faceplate in Black and Craftsman inlay in Black with Starfire Crystals



Regular backing plate, Vignette Tudor faceplate in Black with Black Crystals and optional Volcanic Stones

STANDARD FEATURES

- Horizon contemporary linear fire bed with a generous range of media options
- Heat radiating ceramic glass with safety screen
- 6-tube heat exchanger for max efficiencies
- Variable speed blower for max heat distribution
- Electronic ignition with SureFire™ switch
- Proflame I GTMF remote control
- 30° angled flue for versatile installation
- Direct vent to increase efficiency & warmth retention
- Natural gas
- Limited lifetime warranty

OPTIONS

- Vignette faceplates in various designs and colors
- Vignette inlays in various designs and colors
- Faceplate spacer for shallow fireplace installations
- Driftwood log set, crystals or firebeads in various colors
- Volcanic Stones, Spa Stones, or Accent River Pebbles
- Reflective black enamel interior panels
- Small, regular, arched, oversized and custom backing plates
- Mantel deflector for reduced clearances
- Hearth trim kits for raised hearth installations
- Wall thermostat
- Regency flex liners
- Propane conversion kit

REGENCY ENERGY™ E33

Large Gas Fireplace Insert



E33 shown with Low Profile faceplate and brick panels.

AN ATTRACTIVE HEAT SOURCE

The E33 large gas fireplace insert is a high-efficiency heat source that is designed to seal old drafty fireplaces and provide controllable gas heat. With a standard variable-speed blower, the E33 helps circulate air within the room, distributing it further than radiant heat alone. This unit is a sealed system that uses outside air for combustion – making it perfect for airtight homes.

SPECIFICATIONS	NATURAL GAS	PROPANE
Input (BTU)	38,000	35,500
Turn down to (BTU)	20,000	19,000
Efficiency (steady state)	70.14%	70.73%
EnerGuide Rating (Canada only)	60.70%	61.49%

MINIMUM FIREPLACE OPENING (VIGNETTE FACEPLATE)	
Width (front)	32-1/4"
Width (rear)	25"
Height	24"
Depth (without spacer)	18"
Depth (with spacer)	16-3/4"

Note: Only available in select markets.



E33 shown with Vignette faceplate in Black, Door inlay in Black and brick panels.

STANDARD FEATURES

- Heat radiating ceramic glass with safety screen
- Log set with glowing embers
- Flame height adjustment control
- Variable speed blower
- Proflame I GTM remote control
- 30° angled flue for versatile installations
- Standing pilot system
- Direct spark ignition
- Natural gas
- Limited lifetime warranty

OPTIONS

- Faceplates in low profile or Vignette design
- Vignette door inlay in various colors
- Custom backing plate
- Brick panels
- Wall thermostat
- Installation spacer
- Regency flex liners
- Propane conversion kit

REGENCY LIBERTY® L234

Small Gas Fireplace Insert



L234 shown with Low Profile faceplate and brick panels.

COMPACT SIZE FOR TIGHTER OPENINGS

Designed to fit smaller openings in existing masonry fireplaces, and inefficient steel fireplaces, the L234 small gas insert delivers efficient heat with stylish good looks. Highly realistic logs make this quality, small gas insert an excellent choice for small to medium size spaces.

SPECIFICATIONS	NATURAL GAS	PROPANE
Input (BTU)	23,500	21,500
Turn down to (BTU)	16,500	17,000
Efficiency (steady state)	73.94%	74.67%
EnerGuide Rating (Canada only)	63.34%	64.73%

STANDARD FEATURES

- Heat radiating ceramic glass with safety screen
- Log set with glowing embers
- Flame height adjustment control
- Variable speed blower
- Proflame I GTM remote control
- Standing pilot system with 7-Day timed shut off
- Direct spark ignition
- Direct vent to increase efficiency & warmth retention
- Installation spacer
- Natural gas
- Limited lifetime warranty

MINIMUM FIREPLACE OPENING (VIGNETTE FACEPLATE)	
Width (front)	25"
Width (rear)	16"
Height	17"
Depth (without spacer)	14"
Depth (with spacer)	--

OPTIONS

- Low profile faceplate
- Custom backing plate
- Adjustable hearth riser
- Brick panels
- Basic or programmable thermostat
- 3" to 2" air intake reducer
- Regency flex liners
- Propane conversion kit

Note: This unit is only available in select markets.

REGENCY ENERGY™ U31

Medium Gas Fireplace Insert



U31 shown with Low Profile faceplate and brick panels.

SPECIFICATIONS	NATURAL GAS	PROPANE
Input (BTU)	30,000	28,000
Turn down to (BTU)	20,600	22,000
Efficiency (steady state)	58.45%	59.29%
EnerGuide Rating (Canada only)	51.42%	47.41%

MINIMUM FIREPLACE OPENING (VIGNETTE FACEPLATE)

Width (front)	26-1/2"
Width (rear)	22-1/2"
Height	21"
Depth (without spacer)	--
Depth (with spacer)	15"

STANDARD FEATURES

- Heat radiating ceramic glass with safety screen
- Log set with glowing embers
- Flame height adjustment control
- Variable speed blower
- Proflame I GTM remote control
- Standing pilot system
- Direct spark ignition
- B vent
- Installation spacer
- Natural gas
- Limited lifetime warranty

OPTIONS

- Low profile faceplates
- Custom backing plate
- Contour faceplate
- Hearth trim kit
- Black louvers
- Brick panels
- Basic or programmable wall thermostat
- Regency flex liners
- Propane conversion kit

Note: This unit is only available in select markets.

ATMOSPHERE COLLECTION – ACCESSORIES

Mix & match accessories with almost 450 different combinations of accessories to create the look you desire. The modular accessory system, featured in our most flexible gas inserts ever, enables you to tailor your fireplace to match your home and décor perfectly.

FRONT OPTIONS



3-sided & 4-sided Finishing Trim



Regular Faceplate with Premium Sunset Bronze Surround



Flush 3-Sided Faceplate



Flush 4-Sided Faceplate



Flush Faceplate with Traditional Surround

PREMIUM SURROUNDS



Black



White



Sunset Bronze



Grey



Brushed Nickel



Black



Brushed Antique Copper

TRADITIONAL SURROUNDS

INTERIOR PANEL OPTIONS



Brown Brick

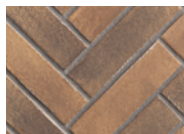

Herringbone Brick



Castlestone Brick



Volcanic Black Brick



Painted Black



Reflective Black Glass

FIREBED OPTIONS



Oak Log Set



Birch Log Set



Driftwood Log Set

BACKING PLATES



Custom 3-sided



Custom 4-sided



Oversized

ATMOSPHERE COLLECTION – SPECIFICATIONS

ACCESSORIES		Gi25 (ELECTRONIC IGNITION)	Gi29L STANDING PILOT 821 (CANADA ONLY)	Gi29LU STANDING PILOT 820 (US ONLY)	Gi29LE • Gi33LE ELECTRONIC IGNITION
Ceramic Glass		✓	✓	✓	✓
Proflame II Remote Control		✓	•	•	✓
On/Off Remote Control with Thermostat		•	★	✓	•
Blower (with Fan Speed Control)		✓	★	✓	✓
Emberbed Lights		•	•	•	✓
Inner Panels (must choose 1)	Brown Brick	★	★	★	★
	Herringbone Brick	★	★	★	★
	Castlestone Brick	•	★	★	★
	Volcanic Black Brick	★	★	★	★
	Reflective Black Glass	★	★	★	★
	Painted Black	✓	★	★	★
Faceplates with Safety Screen (must choose 1)	Regular	★	★	★	★
	Flush 3-Sided	★	★	★	★
	Flush 4-Sided	★	★	★	★
	3-Sided Finishing Trim	★	★	★	★
	4-Sided Finishing Trim	★	★	★	★
Premium Surrounds	Black	•	★	★	★
	Grey	•	★	★	★
	White	•	★	★	★
	Sunset Bronze	•	★	★	★
	Brushed Nickel	•	★	★	★
Traditional Surrounds	Black	•	★	★	★
	Brushed Antique Copper	•	★	★	★
Backing Plates	Oversized	★	★	★	★
	Custom 3-Sided	★	★	★	★
	Custom 4-Sided	★	★	★	★
Media (must choose 1)	Driftwood Log Set	★	★	★	★
	Birch Log Set	★	★	★	★
	Oak Log Set	★	★	★	★
	*Log Grate/Ember Media <i>(Must order when purchasing either oak or Birch log set)</i>	•	★	★	★
Wall Thermostat	Basic	★	★	★	★
	Programmable	★	★	★	★
Wifi Kit		★	•	•	★
Mantel Deflector		★	★	★	★
Adjustable Hearth Trim		★	★	★	★
Propane Conversion Kit		•	★	★	★
30° angled flue		✓	✓	✓	✓

- Not available
- ✓ Standard
- ★ Optional

NOTE: The premium surrounds may only be used on the regular faceplate and the traditional surrounds on the flush 3-sided faceplate.

LIBERTY AND HORIZON FACEPLATES

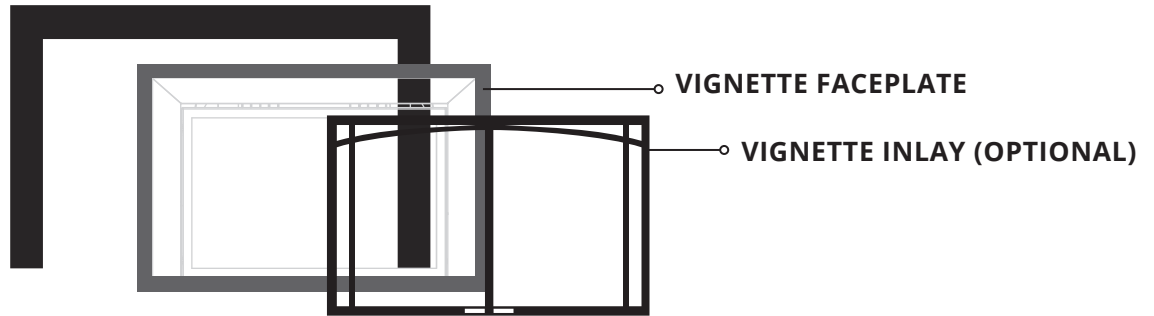

BACKING PLATE OPTIONS*



Small Backing Plate

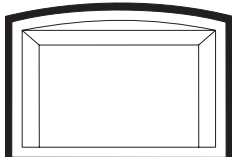

Arched Backing Plate



Regular Backing Plate

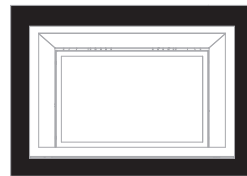

4-sided Regular Backing Plate

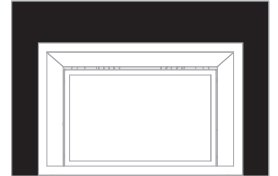

Oversized Backing Plate

*Custom sizes also available

VIGNETTE FACEPLATE OPTIONS (NOT AVAILABLE ON ALL MODELS)



Vignette with 3-sided Backing Plate

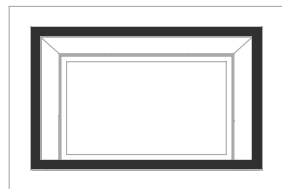

Vignette with 4-sided Backing Plate

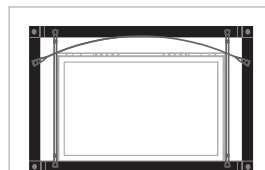

Tudor Rustic Vignette Faceplate

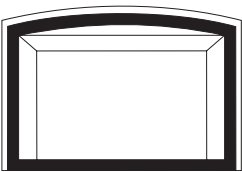

Arched Vignette Faceplate

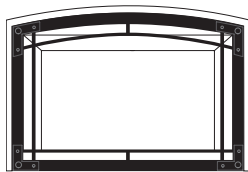

Decorative Arched Vignette Faceplate

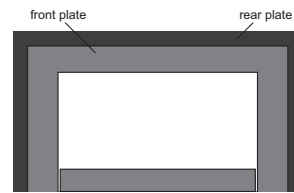

Low Profile Faceplate

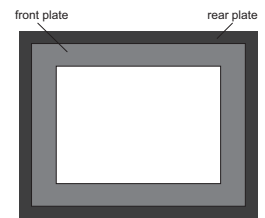

Low Profile Faceplate (4-sided)

VIGNETTE INLAY OPTIONS



Vignette Door Inlay**



Vignette Craftsman Inlay**

VIGNETTE FACEPLATE & VIGNETTE INLAY FINISHES



Black



Black Chrome



Tuscan Sunset



Platinum
(Not available
for inlays)

**LR13E/HRI3E Inlay designs are not exactly as shown

OPTIONS

CRYSTALS & FIREBEADS



Crystals - Black



Crystals - Copper



Crystals - Starfire



Firebeads - Black

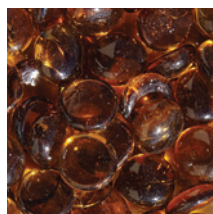

Firebeads - Caramel Luster



Firebeads - Glacier Ice

STONES & LOGS



Volcanic Stones - Gray



Volcanic Stones - Tan



Ceramic Spa Stones



Natural River Pebbles



Driftwood
Ceramic Log Set

INNER PANELS



Reflective
Black Enamel Panels



Standard - Rustic Brown



Standard - Old Town Red



Standard - Volcanic Black

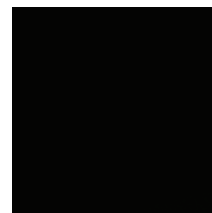

Black Steel
*(Only Available for
LRi4E and HRi4E)*

ACCESSORIES

ACCESSORIES - AT A GLANCE			LRI3E	HRI3E	LRI4E	HRI4E	LRI6E	HRI6E	E33	U31	L234
Horizon firebed	Crystals in various colors		•	★	•	★	•	★	•	•	•
	Firebeads in various colors		•	★	•	★	•	★	•	•	•
	Ceramic spa stones		•	★	•	★	•	★	•	•	•
	Volcanic stones		•	★	•	★	•	★	•	•	•
	Driftwood log set (natural gas only on HRI4E & HRI6E)		•	★	•	★	•	★	•	•	•
Backing plates	Small		★	★	★	★	★	★	•	•	•
	Regular		★	★	★	★	★	★	•	•	•
	4-sided regular		★	★	★	★	★	★	•	•	•
	Oversized		★	★	★	★	★	★	•	•	•
	Arched		★	★	★	★	★	★	•	•	•
Vignette faceplates	Vignette	Black	★	★	★	★	★	★	•	•	•
		Black chrome	★	★	•	•	•	•	•	•	•
		Platinum	★	★	★	★	★	★	•	•	•
		Tuscan sunset	★	★	★	★	★	★	•	•	•
	Vignette – 4-sided		Black	•	•	•	•	•	★	•	•
	Arched Vignette	Tudor	Black	★	★	★	★	★	★	•	•
Decorative Arched		Black	★	★	★	★	★	★	•	•	•
Vignette inlays	Door inlay		Black	★	★	★	★	★	★	•	•
	Craftsman inlay		Black	★	★	★	★	★	•	•	•
Low profile faceplates	Low profile – 3-sided		Black	•	•	•	•	•	★	★	★
	Low profile – 3-sided – oversize		Black	•	•	•	•	•	★	•	•
	Low profile – 3-sided – custom		Black	•	•	•	•	•	★	★	★
Contour faceplate		Black	•	•	•	•	•	•	★	•	
Louvers		Black	•	•	•	•	•	•	•	★	•
Inner panels	Bricks	Rustic brown	★	•	★	•	★	•	★	★	★
		Old town red	★	•	★	•	★	•	★	★	★
		Volcanic black	★	•	★	•	★	•	•	•	•
	Steel	Black	•	✓	★	★	✓	✓	✓	✓	✓
	Reflective	Black enamel	★	★	★	★	★	★	•	•	•
Safety screen			✓	✓	✓	✓	✓	✓	✓	✓	✓
Spacer			•	•	★	★	★	★	•	•	✓
Hearth trim			★	★	★	★	★	★	★	★	★
Variable speed blower			✓	✓	✓	✓	✓	✓	✓	✓	✓
Wall thermostat			★	★	★	★	★	★	★	★	★
Remote control	Proflame GT		•	•	•	•	•	•	•	✓	•
	Proflame GTM		•	•	•	•	•	•	✓	•	✓
	Proflame GTMF		✓	✓	✓	✓	✓	✓	•	•	•
Turn down flame modulator			✓	✓	✓	✓	✓	✓	✓	✓	✓
Direct vent			✓	✓	✓	✓	✓	✓	✓	•	✓
B-Vent			•	•	•	•	•	•	•	✓	•
Intelligent Ignition system			✓	✓	✓	✓	✓	✓	•	•	•
Propane conversion kit			★	★	★	★	★	★	★	★	★

- Not available
- ✓ Standard
- ★ Optional

NOTE: All product specifications are subject to change without notice. Before installing refer to the relevant product manual for full and up to date information.

OTHER OPTIONS

MAXIMIZING COMFORT AND EFFICIENCY

Regency Fireplace Inserts deliver controllable heat solutions that combine the latest in radiant and convection heat technology with innovative features:

- Adjustable flame/heat control with Proflame remote controls (not available for U31)
- Heat radiating ceramic glass for maximum radiant heat
- Safety screen
- Variable speed blower to distribute heat into the farthest corners of your room
- Intelligent Ignition System* features fuel-saving intermittent pilot ignition (IPI), 7-day continuous pilot mode (CPI), and 5-second Flame Failure Response Time (FFRT) for more reliable startups, even in cold weather.
- Power's Out, Heat's On. Never worry about being cold during a power outage again! All Regency gas fireplaces operate without electricity. Enjoy peace of mind all winter long.

*Not available for L234, U31, E33.

REMOTE CONTROL - INCLUDED



Proflame I GTMF Remote Control



Proflame II GTMF Remote Control

Create optimal comfort with ease and convenience at the touch of a button with a Regency remote control. Our **user-friendly programmable controls** can be set, adjusted, and programmed for your fireplace to turn on at the temperature you want, when you want it.

FEATURE	DESCRIPTION	PROFLAME REMOTES		
		GT	GTM	GTMF
On/off		✓	✓	✓
Child lock		✓	✓	✓
LCD backlit screen		✓	✓	✓
Temperature display	°F / °C	✓	✓	✓
Thermostat	one setting (all days)	✓	✓	✓
Smart thermostat**		✓	✓	✓
Flame adjustment	(6 levels)	•	✓	✓
Fan control	(6 levels)	•	•	✓

- Not available
- ✓ Standard

**Smart Thermostat - Rather than a thermostat that simply turns your fireplace on and off, the smart control function allows you to set your desired room temperature. As the room reaches your personal setting, the flame intensity and heat will gradually decrease - keeping the ambiance of your Regency fire on with less heat output, and the option to turn it off at any time.

SAFETY SCREEN

Regency has integrated a custom designed safety screen into each faceplate design that meets or exceeds current North American safety legislation.

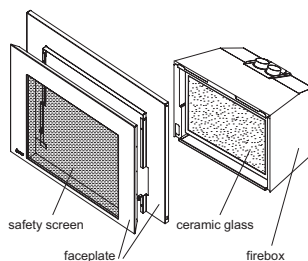

APP CONTROL*

The optional Wifi enabled module provides the ultimate fireplace control with the ProFlame Connect Plus App.



*Available on select units.

OTHER OPTIONS

DIRECT VENT TECHNOLOGY

A Regency gas insert is a specially engineered, sealed fireplace that slips into your existing masonry or pre-fab fireplace to create a high-efficiency heating system with a beautiful fire. The airtight firebox uses outside air for combustion, helping maintain indoor air quality and keeping all the warmth generated from your fireplace in your home.

Even when the fireplace is turned off, the sealed system will prevent cold air from entering the home and warm air from leaving.

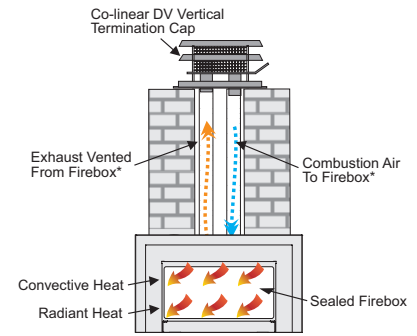

*May be reversed on certain models.

INTELLIGENT IGNITION SYSTEM*

The Intelligent Ignition System, included in Regency gas fireplace inserts, helps to save you money while maintaining fireplace reliability and performance. It does this by ensuring the pilot light is lit only when it is needed. With intermittent pilot ignition (IPI), the pilot light is lit only before the fireplace is used.

For colder climates, the fireplace can also be set to **continuous pilot mode (CPI)**, where the pilot will stay lit for up to 7 full days between uses. With a new 5-second **Flame Failure Response Time (FFRT)** sensor, the ability to light the pilot light the first time is improved drastically, especially in cold climates. Experience increased reliability, performance and lower gas bills with the intelligent ignition system from Regency.

*Not available on L234, U31, E33.

SPREAD THE WARMTH

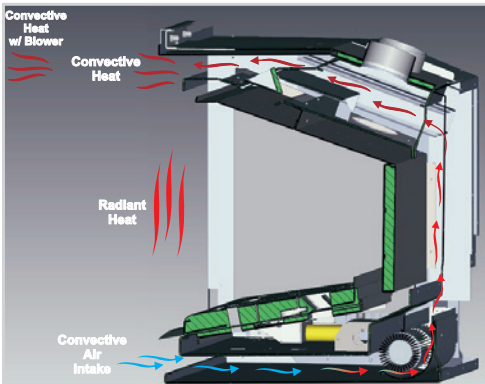

Blower

REMARKABLE EFFICIENCY

The precision-engineered heat exchanger systems dramatically increase the overall heating efficiency of these Regency gas inserts. The cold air from your room passes through the pre-heated heat exchanger system, which is then re-distributed back into your room as comforting warm air (also known as convection heat).

POWERFUL RADIANT HEAT

Not only do these gas inserts include the latest innovations in fireplace technology and efficiencies, they also generate a large amount of radiant heat from the flames of the fire package. The heat from the fire radiates through the ceramic glass and transfers that warmth to you, providing the perfect combination of radiant and convective heat distribution.

VARIABLE SPEED BLOWER TO MAXIMIZE EFFICIENCY

Regency blowers are a standard feature with all gas inserts. A blower will let you enjoy the warmth of your fireplace from any corner of your living space. Our quiet blowers increase the efficiency of your fireplace by pushing the heat produced by your fireplace forward, distributing it further, and evenly into your room.

Gi25, Gi29 & Gi33 SPECIFICATIONS

Three-Sided Faceplate

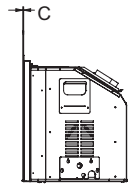
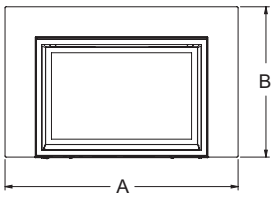

Four-Sided Faceplate

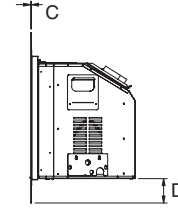
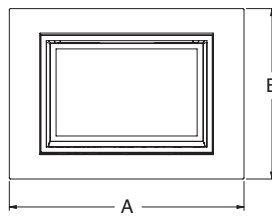

	FACEPLATE	DIMENSIONS			
		A - WIDTH	B - HEIGHT	C - DEPTH	D - BOTTOM HEIGHT
Gi25	Regular Faceplate	35-3/4"	23-1/4"	1-1/4"	--
	3-Sided Flush Faceplate	35-3/4"	23-1/4"	1/8"	--
	4-Sided Flush Faceplate	35-3/4"	26-3/8"	1/8"	4-3/16"
	Screen with 3-Sided Finishing Trim	28-1/4"	18-3/4"	1/16"	--
	Screen with 4-Sided Finishing Trim	28-1/4"	20"	1/16"	1-1/8"
	Oversized Backing Plate	44-5/8"	29-5/8"	1/8"	--
	3-Sided Custom Backing Plate	30-1/4"	19-3/4" - 44-7/8"	1/8"	--
	4-Sided Custom Backing Plate	30-1/4"	22-1/8" - 45"	1/8"	2-1/8" minimum
Gi29	Regular Faceplate	40-3/16"	26"	1-1/4"	--
	Regular Faceplate w/ Premium Surround	40-13/16"	26-3/8"	1-11/16"	--
	3-Sided Flush Faceplate	40-3/16"	26"	1/8"	--
	4-Sided Flush Faceplate	40-3/16"	29-1/4"	1/8"	4-3/16"
	Screen with 3-Sided Finishing Trim	31-7/8"	21-7/8"	1/16"	--
	Screen with 4-Sided Finishing Trim	31-7/8"	23-1/8"	1/16"	1-1/8"
	Oversized Backing Plate	47-1/2"	31-1/2"	1/8"	--
	3-Sided Custom Backing Plate	33-7/8" - 56-7/8"	22-7/8" - 44-7/8"	1/8"	--
	4-Sided Custom Backing Plate	33-7/8" - 69"	25-1/8" - 45"	1/8"	2-1/8" minimum
	Flush Faceplate w/Traditional Surround	45-3/4"	28-3/4"	2-1/4"	--
Gi33	Regular Faceplate	46-5/16"	30-7/8"	1-5/16"	--
	Regular Faceplate w/ Premium Surround	46-3/4"	31-1/8"	1-11/16"	--
	3-Sided Flush Faceplate	46-1/8"	30-3/4"	1/8"	--
	4-Sided Flush Faceplate	46-1/8"	37-1/16"	1/8"	6"
	Screen with 3-Sided Finishing Trim	35-15/16"	25-11/16"	1/16"	--
	Screen with 4-Sided Finishing Trim	35-15/16"	26-15/16"	1/16"	1-1/8"
	Oversized Backing Plate	50-1/4"	33"	1/8"	--
	3-Sided Custom Backing Plate	38" - 56-7/8"	26-3/4" - 44-7/8"	1/8"	--
	4-Sided Custom Backing Plate	38" - 69"	29" - 45"	1/8"	2-1/8" minimum
	Flush Faceplate w/Traditional Surround	51-5/8"	30-3/4"	2-3/16"	--

NOTE: All product specifications are subject to change without notice.
Always refer to the relevant product manual for full and up-to-date information.

Gi25, Gi29 & Gi33 SPECIFICATIONS

MINIMUM FIREPLACE DIMENSIONS

DIMENSIONS							
MODEL	A - HEIGHT	B - MAX. LINTEL BAR DEPTH	C - DEPTH	D - DAMPER OPENING	E - FRONT DEPTH TO TAPER	F - WIDTH (REAR)	G - WIDTH (FRONT)
Gi25	17"	10-1/2"	15"	8" x 4" min	1-5/8"	15"	25"
Gi29	20-1/4"	11-3/8"	16-3/4"	8" x 4" min.	2-5/8"	20"	29"
Gi33	24"	12-1/4"	18"	9" x 5" min.	3-1/2"	22-3/8"	33"

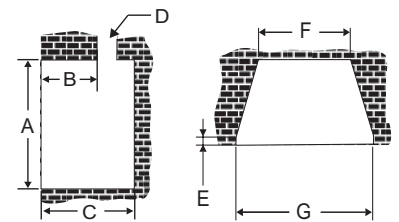

	FACEPLATE	DIMENSIONS				
		A - MINIMUM INSTALL WIDTH	B - MINIMUM INSTALL HEIGHT	C - MINIMUM INSTALL DEPTH	D - MINIMUM REAR WIDTH	E - TAPER DEPTH
Gi25	Regular Faceplate	25"	17"	15"	15"	1-5/8"
	Regular Faceplate w/ Backing Plate	26-3/4"	18-1/4"	15"	15"	3-1/8"
	Flush Faceplate	26-1/2"	18"	16-1/4"	15"	2-5/8"
	Flush Faceplate w/ Backing Plate	26-3/4"	18-1/8"	16-1/8"	15"	4"
	4-Sided Flush Faceplate	26-1/2"	18-1/8"	16-1-4"	15"	2-5/8"
	Finishing Trim	26-1/2"	18"	16-1-4"	15"	2-5/8"
	Finishing Trim w/ Backing Plate	26-1/4"	18-1/4"	16-1/8"	15"	4-1/4"
	4-Sided Finishing Trim	26-1/2"	18-1/8"	16-1/4"	15"	2-5/8"
Gi29	Regular Faceplate	28-7/16"	20-1/4"	16-11/16"	20"	2-13/16"
	Regular Faceplate w/ Backing Plate	30-7/8"	21-7/16"	16-3/4"	20"	2-11/16"
	Regular Faceplate w/ Premium Surround	28-7/16"	20-1/4"	16-5/8"	20"	2-5/8"
	Regular Faceplate w/ Premium Surround and Backing Plate	30-7/8"	21-7/16"	16-1/2"	20"	2-1/2"
	Flush Faceplate	30"	21-1/16"	17-15/16"	20"	3-7/8"
	Flush Faceplate w/ Backing Plate	30-7/8"	21-7/16"	17-13/16"	20"	3-3/4"
	4-Sided Flush Faceplate	30"	21-5/16"	17-15/16"	20"	3-7/8"
	Finishing Trim	30"	21-1/16"	18"	20"	3-15/16"
	Finishing Trim w/ Backing Plate	30-7/8"	21-7/16"	17-7/8"	20"	3-7/8"
	4-Sided Finishing Trim	30"	21-5/16"	18"	20"	3-15/16"
	Flush Faceplate w/Traditional Surround	28-7/16"	20-1/4"	15-15/16"	20"	1-7/8"
Gi33	Regular Faceplate	33"	24"	18"	22-3/8"	3-1/2"
	Regular Faceplate w/ Backing Plate	30-7/8"	21-7/16"	17-7/8"	22-3/8"	2-11/16"
	Regular Faceplate w/ Premium Surround	28-7/16"	20-1/4"	17-3/4"	22-3/8"	2-5/8"
	Regular Faceplate w/ Premium Surround and Backing Plate	30-7/8"	21-7/16"	17-5/8"	22-3/8"	2-1/2"
	Flush Faceplate	30"	21-1/16"	19-3/16"	22-3/8"	3-7/8"
	Flush Faceplate w/ Backing Plate	34-7/8"	25-1/4"	19-1/8"	22-3/8"	4-3/8"
	4-Sided Flush Faceplate	34-1/8"	25"	19-1/4"	22-3/8"	4-1/2"
	Finishing Trim	34-3/16"	24-7/8"	19-1/4"	22-3/8"	4-1/2"
	Finishing Trim w/ Backing Plate	30-7/8"	25-1/4"	19-3/16"	22-3/8"	4-1/8"
	4-Sided Finishing Trim	34-3/16"	25"	19-1/4"	22-3/8"	4-1/2"
	Flush Faceplate w/Traditional Surround	33"	24"	17-1/8"	22-3/8"	2-1/2"

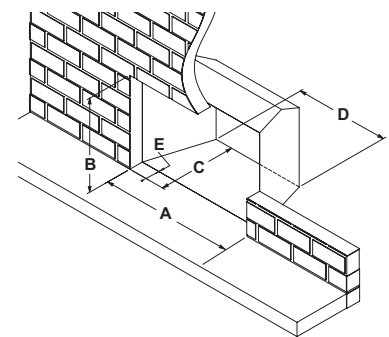

NOTE: All product specifications are subject to change without notice. Always refer to the relevant product manual for full and up-to-date information.

DIMENSIONS

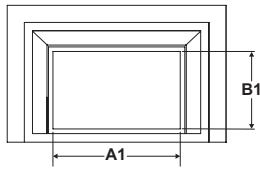

FRONT VIEW

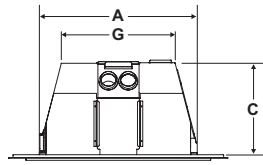

TOP VIEW

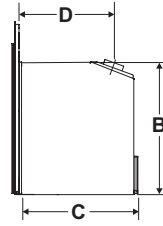

**SIDE VIEW OF HRI6E,
LRI6E, HRI4E, LRI4E,
HRI3E, LRI3E, E33, L234**

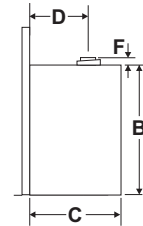

**SIDE VIEW
OF U31**

UNIT	A	B	A1	B1	C	D	F	G
HRI6E	33-15/16"	23-5/8"	28-3/16"	18-5/16"	19-3/16"	14-11/16"	--	24-1/2"
LRI6E	33-15/16"	23-5/8"	28-3/16"	18-5/16"	19-3/16"	14-11/16"	--	24-1/2"
HRI4E	30"	20"	24-3/16"	14-3/4"	17-7/8"	14-5/16"	--	21-11/16"
LRI4E	30"	20"	24-3/16"	14-3/4"	17-7/8"	14-5/16"	--	21-11/16"
HRI3E	28"	19"	22-11/16"	14-1/4"	14"	10-3/8"	--	21-1/4"
LRI3E	28"	19"	22-11/16"	14-1/4"	14"	10-3/8"	--	21-1/4"
E33	32-1/4"	23-3/4"	30-3/8"	14-3/4"	16-1/4"	11-1/16"	--	24-1/2"
U31	26-1/16"	20-1/4"	24-1/2"	13"	13-1/2"	11"	11/16"	22-1/2"
L234	24-3/4"	16-7/8"	17-3/4"	12-1/2"	14-11/16"	11-3/4"	--	14-3/4"

BACKING PLATE DIMENSIONS

BACKING PLATE	HRI6E		LRI6E		HRI4E		LRI4E		HRI3E		LRI3E	
	WIDTH	HEIGHT	WIDTH	HEIGHT	WIDTH	HEIGHT	WIDTH	HEIGHT	WIDTH	HEIGHT	WIDTH	HEIGHT
Small	41"	27-3/4"	41"	27-3/4"	37-1/8"	23-5/8"	37-1/8"	23-5/8"	31-1/4"	23-3/8"	31-1/4"	23-3/8"
Regular (3-sided)	47-3/8"	30-1/2"	47-3/8"	30-1/2"	41-5/8"	26"	41-5/8"	26"	35-3/4"	25-5/8"	35-3/4"	25-5/8"
Regular (4-sided)	47-3/8"	34-1/8"	47-3/8"	34-1/8"	41-5/8"	29-1/4"	41-5/8"	29-1/4"	35-3/4"	28-5/8"	35-3/4"	28-5/8"
Oversized	48-3/8"	33"	48-3/8"	33"	44"	30"	44"	30"	38-3/16"	29-5/8"	38-3/16"	29-5/8"
Custom Backing Plate	Custom Order Only											

BACKING PLATE	HRI6E/LRI6E			HRI4E/LRI4E			HRI3E/LRI3E		
	WIDTH	CENTRE HEIGHT	CORNER HEIGHT	WIDTH	CENTRE HEIGHT	CORNER HEIGHT	WIDTH	CENTRE HEIGHT	CORNER HEIGHT
Arched	50-7/8"	33-1/16"	29-13/16"	45-7/8"	28-15/16"	25-15/16"	40-15/16"	27-11/16"	24-1/2"

NOTE: All product specifications are subject to change without notice.
Always refer to the relevant product manual for full and up-to-date information.

SPECIFICATIONS

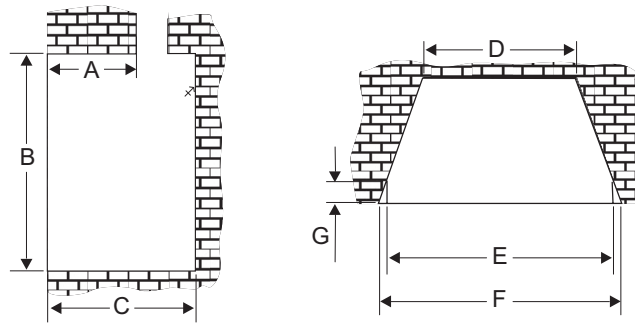

MINIMUM FIREPLACE OPENINGS		A	B	C	D	E	F	G
HRI6E	Vignette Faceplate	12-1/2"	24"	19-1/2"	25"	34"	37"	4-3/4"
	Vignette Faceplate + Spacer	10"	24"	16-3/4"	25"	34"	35-3/8"	2-1/4"
	Arched Vignette Faceplate	13-1/2"	25-3/4"	22-3/8"	25"	35-3/4"	37"	6"
	Arched Vignette Faceplate + Spacer	12"	24"	19-1/2"	25"	34"	36-1/4"	4-3/4"
LRI6E	Vignette Faceplate	12-1/2"	24"	19-1/2"	25"	34"	37"	4-3/4"
	Vignette Faceplate + Spacer	10"	24"	16-3/4"	25"	34"	35-3/8"	2-1/4"
	Arched Vignette Faceplate	13-1/2"	25-3/4"	22-3/8"	25"	35-3/4"	37"	6"
	Arched Vignette Faceplate + Spacer	12"	24"	19-1/2"	25"	34"	36-1/4"	4-3/4"
HRI4E	Vignette Faceplate	12-1/4"	20"	18"	22"	30"	35-5/8"	4-3/8"
	Vignette Faceplate + Spacer	10"	20"	15-3/4"	22"	30"	31-1/4"	2-1/8"
	Arched Vignette Faceplate	14"	21-1/2"	21-1/8"	22"	30-1/2"	37"	5-3/8"
	Arched Vignette Faceplate + Spacer	12-1/2"	20"	17-1/2"	22"	30"	36-1/4"	4"
LRI4E	Vignette Faceplate	12-1/4"	20"	18"	22"	30"	35-5/8"	4-3/8"
	Vignette Faceplate + Spacer	10"	20"	15-3/4"	22"	30"	31-1/4"	2-1/8"
	Arched Vignette Faceplate	14"	21-1/2"	21-1/8"	22"	30-1/2"	37"	5-3/8"
	Arched Vignette Faceplate + Spacer	12-1/2"	20"	17-1/2"	22"	30"	36-1/4"	4"
HRI3E	Vignette Faceplate	8-5/8"	19-1/2"	14-1/2"	21-5/8"	28-1/2"	31-1/8"	4"
	Arched Vignette Faceplate	8-5/8"	19-1/2"	14-1/2"	21-5/8"	28-5/8"	31-1/8"	4"
LRI3E	Vignette Faceplate	8-5/8"	19-1/2"	14-1/2"	21-5/8"	28-1/2"	31-1/8"	4"
	Arched Vignette Faceplate	8-5/8"	19-1/2"	14-1/2"	21-5/8"	28-5/8"	31-1/8"	4"
E33	Low Profile Faceplate	9-1/4"	25-1/2"	18"	25"	N/A	35-1/4"	N/A
	Low Profile Faceplate + Spacer	8"	24-3/16"	16-3/4"	25"	N/A	32-1/4"	N/A
U31	Low Profile Faceplate	8-1/8"	21"	15"	22-1/2"	N/A	26-1/2"	N/A
L234	Low Profile Faceplate	N/A	17"	14" (with spacer) 15-5/8" (without spacer)	16"	N/A	25"	N/A

A - Max. lintel bar depth
G - Front depth prior to taper

NOTE: All product specifications are subject to change without notice.
Always refer to the relevant product manual for full and up-to-date information.

DIMENSIONS

FACEPLATES	HRI6E		LRI6E		HRI4E		LRI4E		HRI3E		LRI3E	
	WIDTH	HEIGHT	WIDTH	HEIGHT	WIDTH	HEIGHT	WIDTH	HEIGHT	WIDTH	HEIGHT	WIDTH	HEIGHT
Vignette and Rustic Vignette	40-1/16"	26-13/16"	40-1/16"	26-13/16"	35-1/16"	22-11/16"	35-1/16"	22-11/16"	29-1/4"	22-1/8"	29-1/4"	22-1/8"
Vignette Spacer	39-15/16"	26-3/4"	39-15/16"	26-3/4"	34-15/16"	22-5/8"	34-15/16"	22-5/8"	--	--	--	--
Hearth Trim - Sizes	Please See Manual For Details											

FACEPLATES	HRI6E/LRI6E			HRI4E/LRI4E			HRI3E/LRI3E		
	WIDTH	CENTRE HEIGHT	CORNER HEIGHT	WIDTH	CENTRE HEIGHT	CORNER HEIGHT	WIDTH	CENTRE HEIGHT	CORNER HEIGHT
Arched Vignette	45-3/8"	30-7/16"	27-13/16"	40-1/4"	26-1/8"	23-3/4"	35-15/16"	25-3/16"	22-3/4"
Spacer	45-3/8"	30-7/16"	27-13/16"	40-1/4"	26-1/8"	23-3/4"	--	--	--

FACEPLATES	E33		U31		L234		
	WIDTH	HEIGHT	WIDTH	HEIGHT	WIDTH	HEIGHT	
Vignette (3-Sided)	46-1/2"	28-3/4"	--	--	--	--	
Vignette (4-Sided)	46-1/2"	30-7/8"	--	--	--	--	
Custom Faceplate (3-Sided Vignette Only)	Custom Order Only		--	--	--	--	
Spacer (3-Sided Vignette Only)	45"	28"	--	--	--	--	
Low Profile (3-Sided)	Front Plate	42-7/16"	26-3/4"	36"	22-1/8"	29-1/8"	21"
	Rear Plate	46-1/2"	28-11/16"	40-13/16"	24"	32-7/8"	22-7/8"
Low Profile (3-Sided Oversize)	Front Plate	42-7/16"	26-3/4"	--	--	--	--
	Rear Plate	49-9/16"	33-1/8"	--	--	--	--
Low Profile (3-Sided) Custom	Rear Plate	Custom Order Only					
Low Profile (4-Sided) Custom	Rear Plate	Custom Order Only					
Hearth Trim - Sizes	Please See Manual For Details						

MINIMUM CLEARANCE TO COMBUSTIBLES		HRIG6	LRI6E	HRI4E	LRI4E	HRI3E	LRI3E	E33	U31	L234
A	Side Wall	12"	12"	8"	8"	6"	6"	8"	10"	8"
B	Ceiling	60"	60"	60"	60"	60"	60"	72"	67"	73"
C	Mantel Height (Min.)	40"	40"	35"	35"	38"	38"	40"	32-1/2"	38"
	(With Optional Deflector)	36"	36"	32"	32"	28"	28"	N/A	N/A	N/A
D	Mantel Depth (Min.)	1"	1"	1"	1"	1"	1"	0 - 3-1/2"	0 - 3-1/2"	1"
	(With Optional Deflector)	1"	1"	1"	1"	1"	1"	N/A	N/A	N/A
E	Alcove Width	56"	56"	54"	54"	54"	54"	76"	48"	60"
F	Max. Alcove Depth	36"	36"	36"	36"	36"	36"	36"	36"	36"

NON-COMBUSTIBLE HEARTH REQUIREMENT										
G	Hearth Height	1-3/8"	1-3/8"	1/2"	1/2"	1/2"	1/2"	1-1/4"	0"	1-1/2"
H	Hearth Width	44"	44"	40"	40"	36"	36"	45-1/2"	0"	28"
I	Hearth Depth	14"	14"	14"	14"	12"	12"	13"	0"	12"

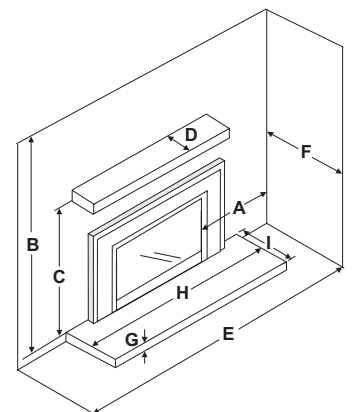

NOTE: All product specifications are subject to change without notice. Always refer to the relevant product manual for full and up-to-date information.



Find More Products at [REGENCY-FIRE.COM](https://www.regency-fire.com)

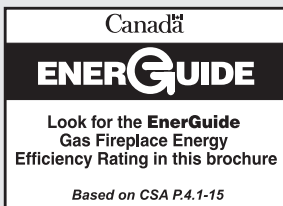

Your Regency Dealer

©2024 FPI Fireplace Products International Ltd. Regency®, Regency Liberty®, Regency Horizon®, Regency Energy™ and Surefire™ are registered or proprietary trademarks of FPI Fireplace Products International Ltd. All rights reserved. Printed in Canada (04/24) Part no. 944-072

Version No: 2024-1